



OPERATING MANUAL

CHANNEL BALING PRESS

**SP 5088**

*Keep this instruction for future use!*

HSM GmbH + Co.KG,  
Austraße 1-9,  
88699 Frickingen / Germany  
Tel. + 49 75 54 2100-0  
Fax + 49 75 54 2100-160  
info@hsm.eu  
www.hsm.eu

# Contents

<b>Nameplate</b>	<b>6</b>
<b>Foreword</b>	<b>7</b>
<b>1 Safety</b>	<b>8</b>
1.1 Notes on safety.....	8
1.1.1 "Work safety" symbol.....	8
1.1.2 "Notice" symbol.....	8
1.2 Classification of hazards.....	8
1.2.1 Danger.....	8
1.2.2 Warning.....	8
1.2.3 Caution.....	8
1.3 Notes on work safety.....	9
1.4 Proper use.....	11
1.5 Inspecting the safety devices.....	12
<b>2 Technical data</b>	<b>16</b>
2.1 KP 88.1 Combined press.....	16
2.1.1 Press data.....	16
2.1.2 Motor data.....	16
2.1.3 Hydraulics.....	16
2.1.4 Pump.....	16
2.1.5 Cylinder.....	16
2.1.6 Oil tank.....	16
2.1.7 Noise emission.....	16
2.2 Shredder FA 500.3.....	17
2.3 Power requirement and fuse rate (3 x 400 V / 50 Hz).....	17
2.4 Operating conditions.....	17
2.5 Accessories.....	17
2.6 SP 5088 explanatory diagram.....	18
2.7 Machine dimensions.....	19
<b>3 Preparations</b>	<b>20</b>
3.1 General instructions.....	20
3.2 Siting the machine.....	20
3.3 Supply connections.....	20
3.4 Settings.....	20
3.5 Transporting the baling press.....	21
3.5.1 Transport to another application site.....	21
3.6 Transporting the shredder.....	22
3.7 Assembling the shredder.....	23
3.8 Assembling the shredder press combination.....	24

<b>4</b>	<b>Commissioning</b>	<b>27</b>
4.1	Baling press controls .....	27
4.1.1	Accessing the SERVICE menu.....	30
4.1.1.1	Select setup mode (Bale finished / press channel / press ram).....	31
4.1.1.2	To display / clear the daily bale meter .....	32
4.1.1.3	Displaying / adjusting: Bale length or No. of strokes.....	32
4.1.1.4	Displaying / adjusting the actual values .....	33
4.1.1.5	Adjusting the user language.....	33
4.1.1.6	To display the error memory.....	34
4.1.1.7	System .....	34
4.2	Shredder control panel .....	35
4.2.1	Display: Baling press not in automatic mode .....	35
4.2.2	Display: Status of the baling press.....	35
4.3	Initial start-up .....	36
4.4	Running in the baling press .....	37
4.4.1	Setting the press channel adjustment cylinder .....	39
4.4.2	Relieve the press channel.....	40
4.5	Drawing in the strapping tape.....	41
4.6	Automatic compression with light barrier.....	42
4.7	Strapping procedure .....	42
4.8	"Sacking" procedure .....	44
4.9	Malfunctions of the baling press .....	45
4.9.1	Error numbers .....	45
4.10	Malfunctions of the shredder .....	46
4.10.1	Overload due to paper jam .....	46
4.10.2	Electric motor overheats .....	46
4.10.3	Emergency stop activated.....	46
4.10.4	Oil reservoir empty.....	47
4.11	Stopping the machine.....	47
4.12	Outdoor use.....	47
<b>5</b>	<b>Inspection and maintenance work</b>	<b>48</b>
5.1	Notes on maintenance.....	48
5.2	Maintenance of the baling press.....	49
5.2.1	Changing the hydraulic fluid / venting filter .....	49
5.2.2	Oiling and greasing moving parts .....	50
5.2.3	Empty the dust tray .....	51
5.3	Maintenance of the FA 500.3 shredder .....	52
5.3.1	Lubricating the drive chains and synchronized wheels (2 x per year) .....	52
5.3.2	Retighten the feed belt.....	53
5.3.3	Check the directional stability of the feed belt .....	53
5.3.4	Check the feed belt for wear .....	53
5.3.5	Emptying the collecting tray.....	54

<b>6</b>	<b>Storage</b>	<b>55</b>
<b>7</b>	<b>Disposal instructions</b>	<b>55</b>
	7.1 Disposal verification form .....	56
<b>8</b>	<b>Using and ordering spare parts</b>	<b>57</b>
	8.1 Customer service address.....	57
<b>9</b>	<b>Electrical circuit diagrams</b>	<b>58</b>
<b>10</b>	<b>KP 88.1 hydraulic diagram</b>	<b>59</b>
<b>11</b>	<b>EC declaration of conformity</b>	<b>60</b>

# Nameplate

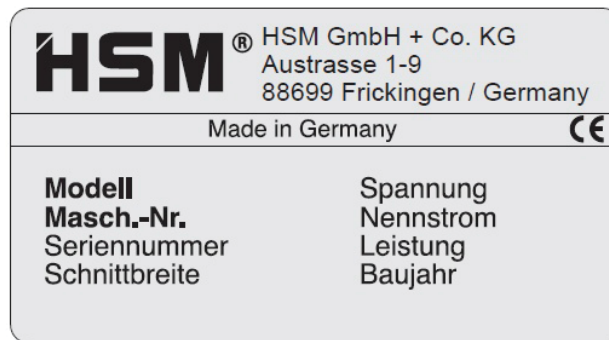
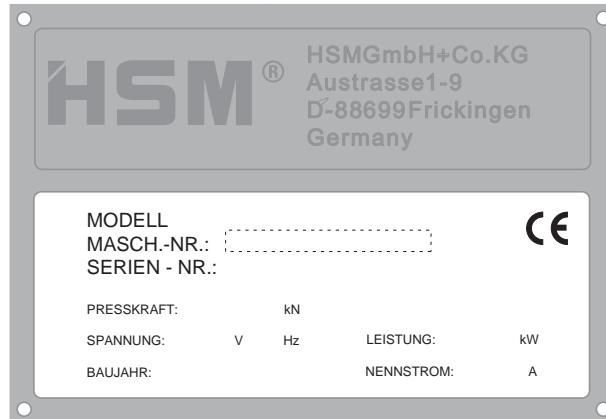

The machine number is specified on the nameplate of the baling press, shown above. Guarantee claims and inquiries cannot be processed if you do not quote the machine number.

Please therefore enter this number into the grey field of the nameplate immediately after receipt of the baling press.

## **Foreword**

This Operating Manual informs you in detail about the start-up and maintenance of your new baling press. It also contains notes on safety which must be observed.

To a great extent, the performance of your baling press depends on its proper application and thorough maintenance. You should carefully read this Operating Manual and the notes on safety and always keep them safe at hand. You can thus prevent accidents, maintain your guarantee claims against the manufacturer and always have an operative baling press.

HSM GmbH + Co. KG permanently aspire to improve their products. They reserve the right to perform any changes and modifications which are deemed necessary. However, this does not imply the obligation for a subsequent modification of already delivered machines.

Technical modifications as compared to the representations and statements in this Operating Manual which become necessary to improve the baling press are reserved.

This Operating Manual is intended for staff installing, operating and servicing the baling press. It includes technical specifications and drawings which must not be copied, distributed or used for competitive purposes or given to third parties completely or in part.

Please contact your local dealer if you still have questions after having read this Operating Manual.

# 1 Safety

## 1.1 Notes on safety

### 1.1.1 "Work safety" symbol



*This symbol marks all work safety notes in this Operating Manual which endanger the health or life of people. Please pay attention to this symbol and exercise particular care in such cases. Please also forward all work safety notes to other users.*

*Apart from the instructions in this manual, you must also follow generally applicable safety and accident prevention regulations.*

### 1.1.2 "Notice" symbol



*This symbol marks information in this manual which requires particular attention so that guidelines, regulations, instructions and correct working procedures are followed and damage to or ruin of the machine and/or other equipment prevented.*

## 1.2 Classification of hazards

### 1.2.1 Danger



*identifies an immediate danger. If not avoided, it will result in death or severe injuries (crippling).*

### 1.2.2 Warning



*identifies a possibly dangerous situation. If not avoided, it could result in death or severe injuries.*

### 1.2.3 Caution



*identifies a possibly dangerous situation. If not avoided, it could result in light or minor injuries. Is also used for warnings concerning damage to material.*



### 1.3 Notes on work safety

**Please pay particular attention to the following notes on work safety:**

- The SP 5088 shredder press combination has been safety-tested by an accredited testing station.  
Nevertheless, incorrect operation and misuse can result in:
  - the health or life of the operator
  - the machine and other valuable equipment
  - the efficient operation of the shredder
- The SP 5088 shredder press combination has been built with the most up-to-date technology. However, the machine can be dangerous if improperly used, even by trained staff, or if used for purposes other than those for which it was designed.
- The operation of the shredder press combination is always subject to local safety and accident prevention regulations.
- The employer must observe and comply with the “minimum safety and health requirements for the use of work equipment by workers at work”. Machinery Directive 2009/104/EC
- The shredder press combination may not be operated by anyone under 16 years of age.
- All those charged with installation, assembly, disassembly, start-up, operation, inspection, maintenance or repair of the baling press must have first read and fully understood the entire operating manual, paying particular attention to the “Safety” section.
- The shredder press combination may only be operated, serviced and repaired by authorised, trained staff. These staff must have been given special instructions on any dangers which may possibly arise.
- Areas of personal responsibility for installation, assembly, re-assembly, set-up, operation and maintenance must be clearly defined and strictly adhered to, in order to avoid confusion which might compromise safety.
- When carrying out installation, disassembly, re-assembly, maintenance, operation, adjustment and maintenance work always observe the shut-down procedures described in the operating manual. Never perform this kind of work on the machine unless it is fully shut down.
- Before performing such tasks make sure the drives and additional mechanisms of the baling press cannot be switched on unintentionally. Turn the main switch to the “0” position and secure it. Pull out the power plug.
- Before starting the machine after repairs, make sure all protective devices are in place.



- Do not carry out any tasks which may endanger your safety while operating the machine.
- Any changes which take place and could impair safety should be reported immediately. Put the machine out of operation until the damage is rectified.
- Always make sure the machine is in perfect condition before you switch it on.
- Make sure the area around the machine is clean and safe.
- Unauthorised modifications and changes to the machine are strictly prohibited. Protective devices may not be removed or otherwise rendered inoperative.
- No work on the machine which is not part of its normal operation may be performed while the machine is still running.
- Never open doors and flaps before the machine has been shut down. Note the instruction plate.
- Test the protective measures installed after any electrical or repair work.
- No platforms or other raised surfaces may be placed near the shredder press combination if they encroach on the specified safety clearances.
- Connecting cables must be laid in such a way that they cannot be tripped over.
- Only persons with the appropriate skills and experience in hydraulics may carry out work on the hydraulic equipment.
- All lines, pipes and bolted joints must be regularly inspected for looseness, leaks and visible damage. Any damage must be repaired immediately. Escaping oil can cause fire and injury.
- Any parts of the system and hydraulic pressure lines that need to be opened must be depressurised according to the assembly instructions before commencing repair work.

## 1.4 Proper use

The **SP 5088** shredder press combination is intended solely for shredding and pressing paper and cardboard. The robust cutting unit is unaffected by staples and paper clips and is even suitable for the destruction of whole volumes of files and folders. Excluding other types of materials.

Operating mode :

Above-mentioned material is fed to the shredder. The crushed material falls through the outlet of the shredder chute directly into the shaft of the press. The pressing operation is initiated by a light barrier in the shaft when a certain level is achieved. The pressing plate moves forward and presses the pressed material in the conical interference channel, wherein it is compressed. The Shredder continues to run during the pressing process. Once the bale has reached a certain length, it must be strapped manually. Then can again be further pressed.

Due to the continuous pressing process, the sprue end compact bales ejected onto a pallet or in a Plastic sack.

Any other use is considered improper. The manufacturer accepts no liability for damage resulting from improper use - the operator carries sole responsibility for such use.

Proper use also includes carrying out installation, assembly, disassembly, start-up, operation and maintenance work as prescribed by the manufacturer. The baling press may only be operated, serviced and repaired by staff who are familiar with these regulations and aware of the dangers.

The shredder press combination may only be operated by authorised, trained staff. Do not carry out any tasks which may endanger your safety while operating the machine.

The relevant accident prevention regulations and any other generally recognised health and safety standards must also be observed.

## **1.5 Inspecting the safety devices**

Check the safety devices:

- at the start of every work shift (when operation was interrupted)
- at least once a week when the operation is interrupted
- after each maintenance or repair

Check the safety devices for:

- specified condition
- specified position
- safe attachment
- specified function

Use the following checklist for your inspection. Correct any defects before starting the machine!

If any defects arise during operation stop the machine immediately and ensure that the defect is corrected.

Do not modify or remove any of the protective devices. Do not deactivate any of the protective devices by modifying the machine.

Modifications to the machine are prohibited for safety reasons!

## Checklist for inspecting the safety devices

Use the following list for your inspection of the safety devices.

Photocopy it for regular inspections.

Tick off the boxes if the check was successful.



Do not start the machine until you have checked every point.



1. All protective plates must be mounted and firmly bolted on. (see picture)

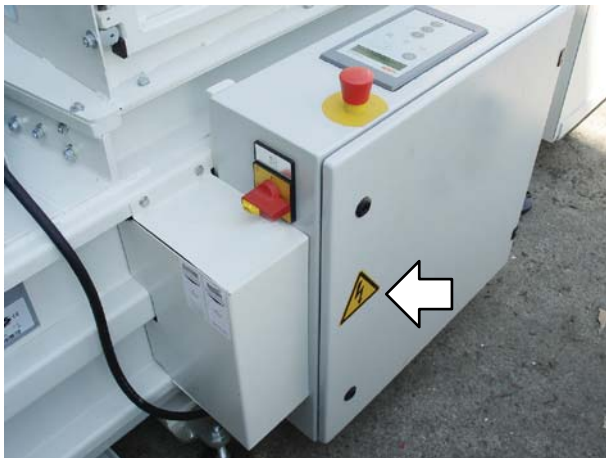

2. The control cabinet must be closed and the "Lightning symbol" warning sign affixed to it.



3. Check the safety switch on the dirt drawer of the baler. The safety switch turns the shredder baler combination immediately or they may no longer be turned on when the dirt tray is open

Try this function out!

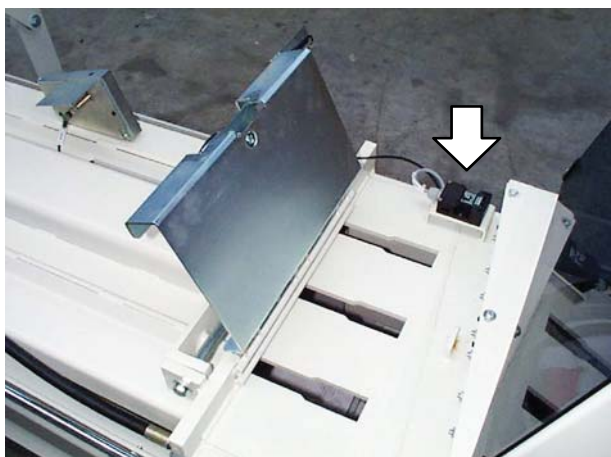

4. Check the safety switch at the strapping flap.  
 When the strapping flap is open, the safety switch immediately switches the machine off or the machine cannot be switched on.

Try this function out!



5. Check the safety switch on the hopper. The safety switch switches the shredder press combination off immediately and prevents it from being switched on again when the inspection flap is opened.

Try this function out!



6. When you press the emergency stop switch bar whilst the machine is running, the shredder and baling press must switch off immediately. The machines can only be switched on again once you have pulled out the switch bar.

Try this function out!

**Ein-Mann-Bedienung**  
**One-man operation**  
**Un seul opérateur**

7. The safety sticker "One-man operation" must be fixed to the shredder.

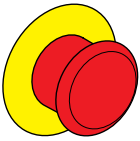

8. The “Safety instruction symbol” sticker must be fixed to the shredder.

8. If you press the emergency stop button when the machine, shredder and baler must be switched off immediately.  
 The machines can be turned on again until you have unlocked the emergency stop button.

Try this function out!

checked
Date .....
Signature .....

## 2 Technical data

### 2.1 KP 88.1 Combined press

Weight	~ 880 kg
Size (L x W x H)	see machine dimension

#### 2.1.1 Press data

Pressing force	85 kN
Specific pressing force	30 N/cm <sup>2</sup>
Cycle time when idling (theoretical)	13 s
Bale size (L x W x H)	500 x 500 x 400-950 mm
Bale weight (depending on material)	40 – 70 kg

#### 2.1.2 Motor data

Rated power $P_n$	4,0 kW
Operating voltage U	400 V / 50 Hz
Rated current $I_n$ at U = 400 V	8,5 A
Output speed $n_{ab}$	1450 min <sup>-1</sup>
Protection class	IP54

#### 2.1.3 Hydraulics

Operating pressure	210 bar
--------------------	---------

#### 2.1.4 Pump

Discharge Q	19,5 l/min
-------------	------------

#### 2.1.5 Cylinder

Pressing cylinder	ø70/50 x 630 mm
Channel adjustment cylinder	ø60/40 x 120 mm

#### 2.1.6 Oil tank

Capacity	27 l
Oil grade	multi-grade oil (DIN 51524-T3) ISO viscosity grade HVLP 22

#### 2.1.7 Noise emission

The sound pressure level, in accordance with DIN 45635 part 27, has the following values:

Idle 1 m / 7 m *)	71 / 69 dB (A)
Full load 1 m / 7 m *)	82 / 79 dB (A)

\*) Distance measured between measuring instrument and machine surface at the hopper.



## 2.2 Shredder FA 500.3

Cutting type	Particle cut			
Cutting size (mm)	10,5 x 40 - 76	7,5 x 40 - 80	6 x 40 - 53	1,9 x 15
Security level DIN 32757 – 1	2	2	3	4
A4 (sheet) cutting performance	70 g/m <sup>2</sup> 80 g/m <sup>2</sup>	600 - 650 510 - 550	500 - 550 425 - 470	400 - 450 340 - 380
Throughput security level 4				200 - 250 kg/h
Intake width	500 mm			
Cutting speed	210 mm/s			
Power supply	3 x 400 V, 50 Hz			
Power consumption with max. number of sheets	7,5 kW			5,5 + 4 kW
Rated current	27 A			31 A
Plug	industrial plug			
Safety fuse Line safety switch Max. mains impedance	Typ „gI“ 35 Ampere K oder C / 32 Ampere 0,1517 Ohm			
<b>Ambient conditions for transport, storage and operation:</b> Temperature Relative humidity Altitude above sea level	-10°C bis +40°C max. 90%, without condensation max. 2.000 m			
<b>Dimenstions W x D x H (mm)</b>	1170 x 1795 x 1795			
<b>Weight</b>	790 kg			920 kg
<b>Sound pressure level</b>	< 70 dB(A)			
Shredded material container volume	530 l (2 x 265 l)			

## 2.3 Power requirement and fuse rate (3 x 400 V / 50 Hz)

	<b>KP 88.1</b>	<b>FA 500.3</b>
Rated power P <sub>n</sub>	4,0 kW	9,2 kW
Rated current I <sub>n</sub>	8,5 A	18,1 A
Power connection plug	CEE 32	industrial plug
Total fuse rating	Shredder press combination 32 A	

## 2.4 Operating conditions

Operating temperature	- 10°C ÷ + 40°C
Operating humidity	max. 90%, without-condensing
Operating altitude	max. 2000 m above sea level

## 2.5 Accessories

PE gusseted bag	570/545 x 1150 x 0,1mm
Order no.:	1.452.995.000

**2.6 SP 5088 explanatory diagram**

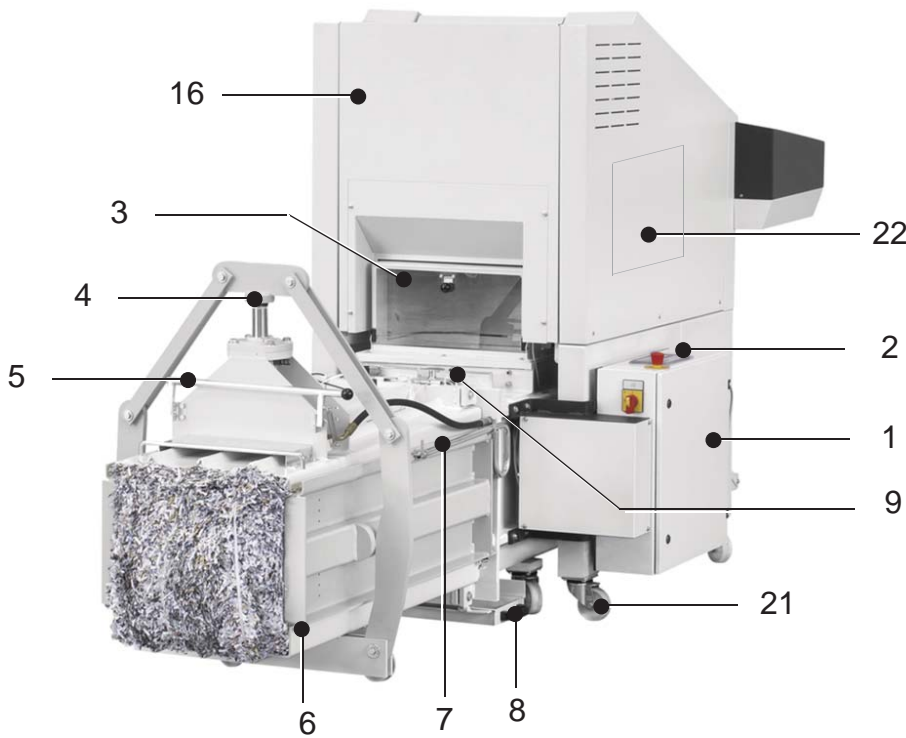

- 1 Press control cabinet
- 2 Press control panel
- 3 Inspection flap
- 4 Press channel adjustment
- 5 Polythene bag attachment
- 6 Press channel
- 7 Tape insertion needle

- 8 Dirt tray
- 9 Strapping flap
- 10 Hydraulic cover
- 11 Tape station
- 12 Press cylinder
- 13 Venting filter
- 14 Hydraulic tank
- 15 Press motor



- 16 Shredder FA 500.3
- 17 Loading table
- 18 Shredder control panel
- 19 Emergency stop switch bar
- 20 Feed belt
- 21 Swivel roller with brake
- 22 Shredder inspection flap
- 23 Oil reservoir opening

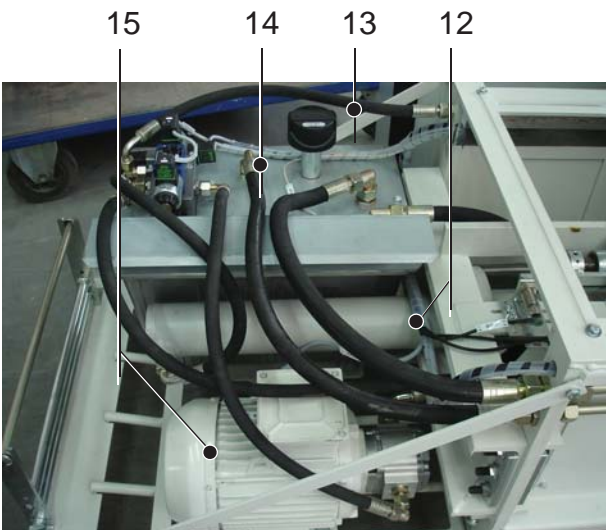

2.7 Machine dimensions

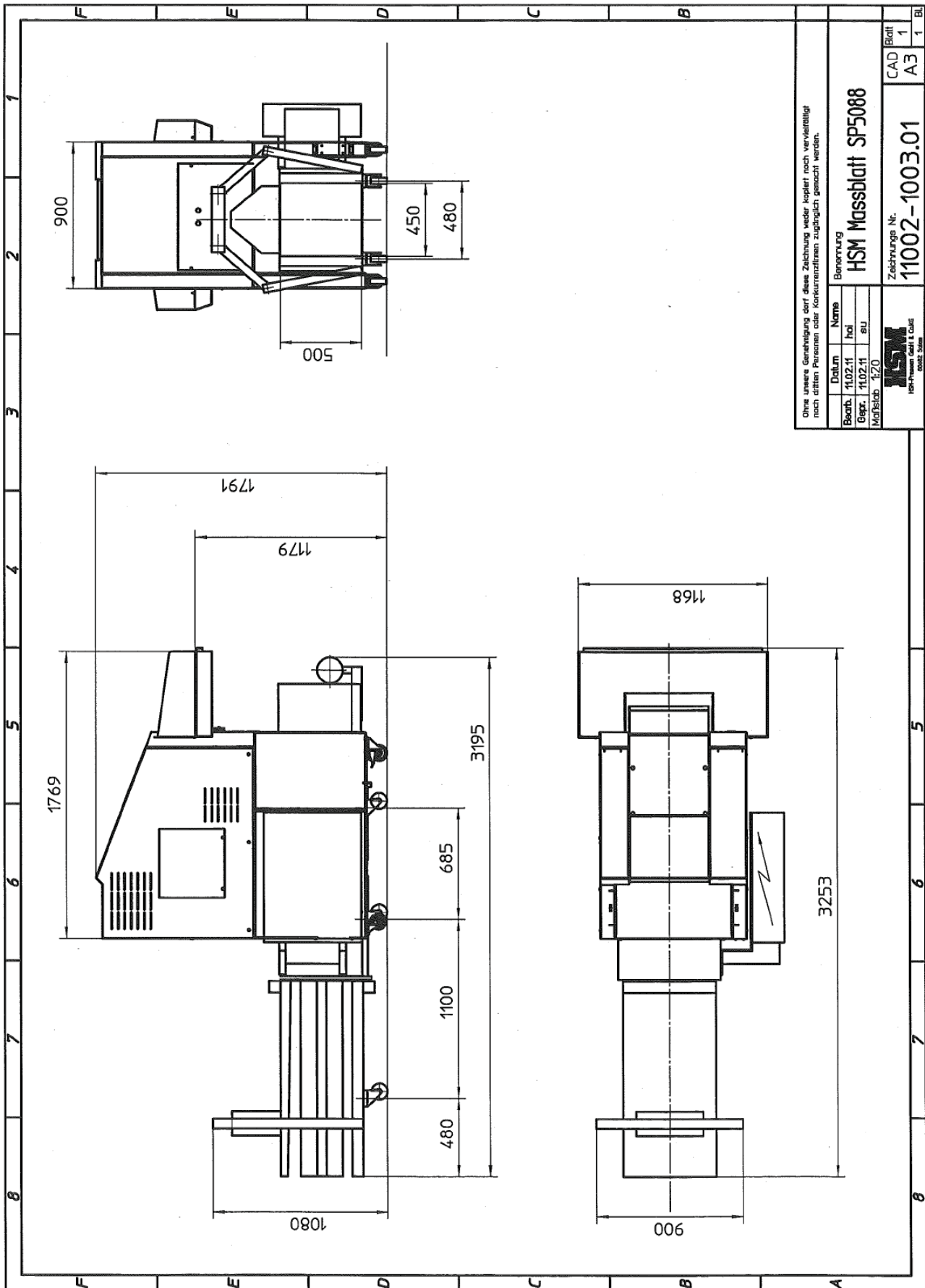

Ohne unsere Genehmigung darf diese Zeichnung weder kopiert noch vervielfältigt noch dritten Personen oder Konkurrenzfirmen zugänglich gemacht werden.

Datum		Name		Benennung	
Boorb.	11.02.11	hol		HSM Massblatt SP5088	
Gepr.	11.02.11	su		Zeichnung Nr. 11002-1003.01	
Maßstab: 1:20		HSM		CAD Blatt 1	
		HSM-Präzision GmbH & Co. KG		A3	
		D-80469 Sigmaringen		1	
				Bl.	

## 3 Preparations

### 3.1 General instructions

We strongly recommend that installation work on the baling press should be carried out by trained HSM engineers.

We accept no liability for damage resulting from incorrect installation.

If you do perform installation tasks yourself, make sure you have read and fully understood the entire operating manual before you start.

### 3.2 Siting the machine

When deciding where to install the machine (e.g. planning by the customer) make sure there is enough space around the machine so that assembly and repair work can be carried out without obstruction. Upstream and downstream machines are to be arranged accordingly.

The installation on the prepared foundation must be such that the shredder baler combination stands evenly.

The shredder press combination may only be operated in dry rooms.  
At temperatures below 0 °C and above 30 °C respectively, use different hydraulic oil that has a suitable viscosity for the baling press or upgrade the tank heater/oil cooler.

### 3.3 Supply connections

Power is supplied via the central control cabinet of the baling press. The control cabinet has a power connection cable with a CEE plug.  
The installation site must have a CEE 5x32A/6H power socket with an appropriate fuse. (see "Technical data")

### 3.4 Settings

In general, all the components have been installed, and the electrical and hydraulic lines connected.

The electrical and hydraulic settings for the various components have been performed by HSM.



**Caution!**

*Unauthorised adjustments to the set values are prohibited and could seriously damage the machine.*

### 3.5 Transporting the baling press

Always use the special bearing points for loading the machine from a lorry using a forklift.



- Place the baling press on a smooth level surface at the installation site.
- Remove the packaging foil and dispose of it in a manner that is environmentally sound.
- Cut through the steel straps.
- Using a forklift, lift the baling press by approximately 10 cm and remove the wooden blocks.
- Open the inspection flap and remove all the items delivered with the machine from the press chamber.

#### 3.5.1 Transport to another application site

Over short distances the channel baling press can be rolled to the operating site. Ensure that the load on the foundation is accounted for and the space requirements fulfilled at the new installation site. An approved electrical connection must be available at the new installation site.



**Caution!**

*Installations on the electrical system or control cabinet may only be carried out by a qualified electrician or one of our service engineers.*

### 3.6 Transporting the shredder

**Caution!**

*When moving the shredder, note that it may topple over. Danger of falling over!*

- Place the shredder on a smooth level surface at the installation site.
- Remove the packaging foil and dispose of it in a manner that is environmentally sound.
- Cut through the steel straps.
- Roll the shredder off the pallet in accordance with the unpacking instructions. The shredder can now be moved on its rollers.



- The loading table must be mounted at the installation site.

### 3.7 Assembling the shredder

The shredder is not fully assembled on delivery.

The loading table is not assembled and should only be assembled at the installation site.

- Attach the table using the M10 nuts (1)

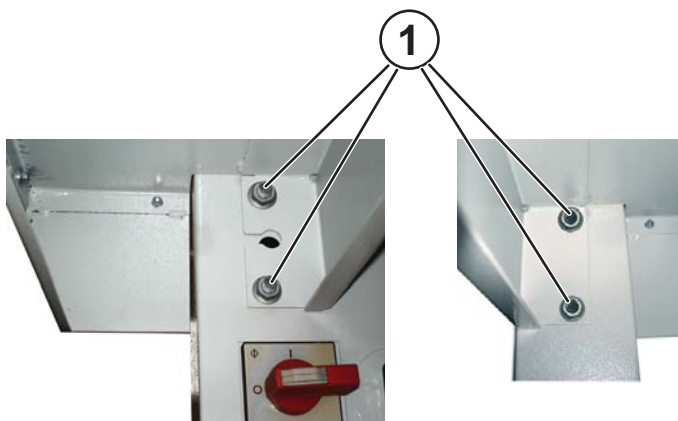

- Insert the plug (connection for the emergency stop switch bar) into the socket and turn it to stop.



### 3.8 Assembling the shredder press combination



**Danger!**

*Open shearing point, blade rollers.*

*Risk of fingers and hands being severed.*

*Neither the shredder nor the combined press may be switched on before both devices have been properly connected and bolted together!*

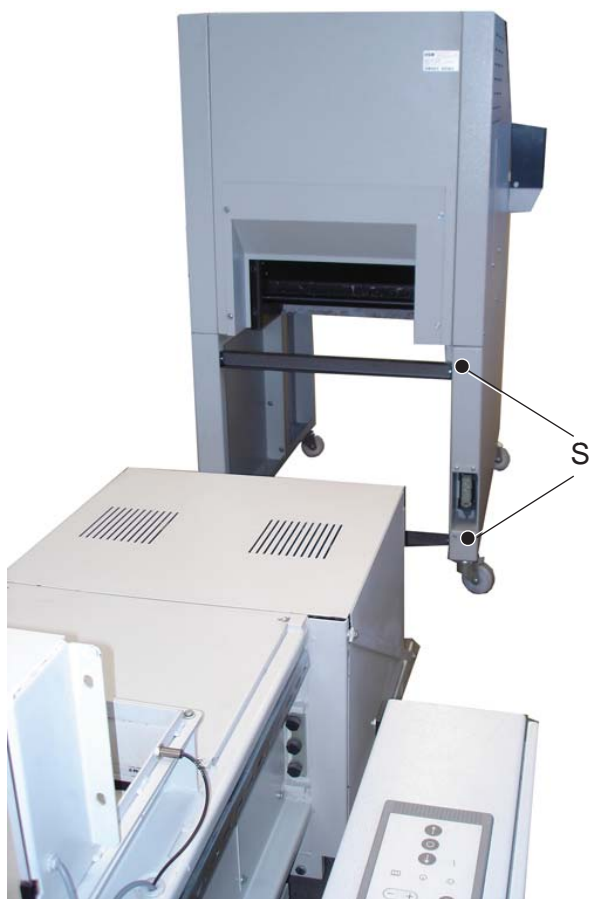

1. Remove the 2 cross braces (S) on the shredder and lock the roller brakes on the press.

2. Push the shredder over the press from behind.

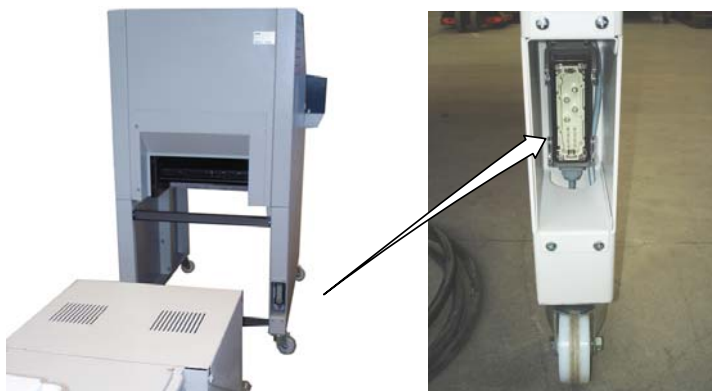

3. Insert the plug of the connection cable into the socket of the shredder and lock the plug in position.



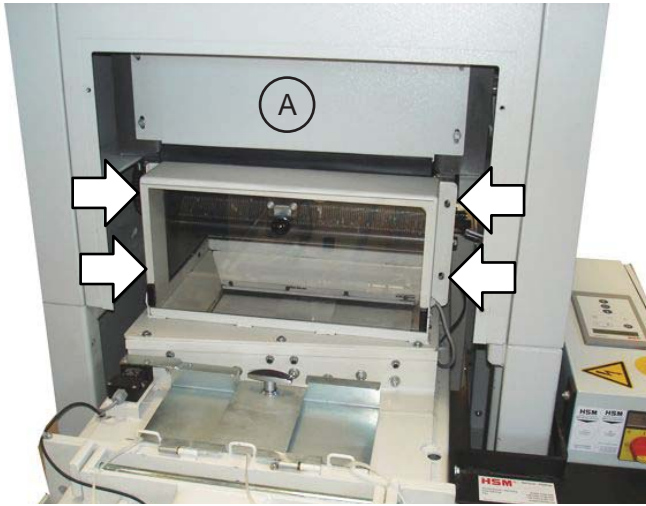

4. Carefully push it forward until the discharge chute of the shredder touches the press hopper. Take care with the cable whilst doing so.
5. If the Shredder cannot be completely pushed up against in the press hopper, the cover (A) must be loosened and subsequently retightened.
6. Bolt the shredder and the baling press together using the 4 nuts.

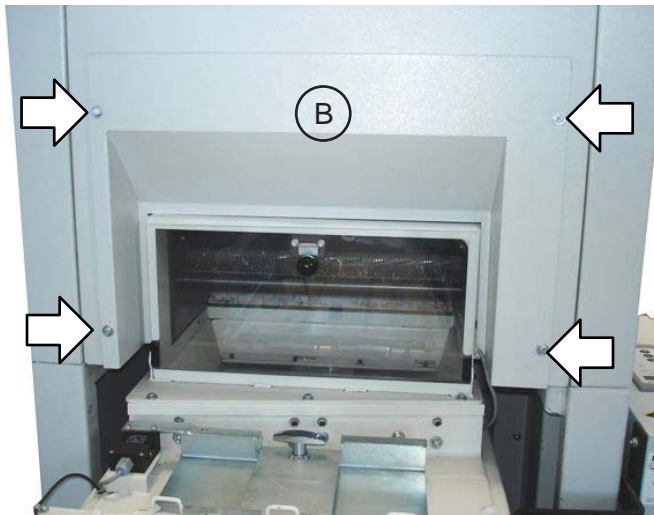

7. Attach the cover plate (B) using the 4 fillister head screws.



8. Insert the plug of the connection cable into the socket of the baling press and lock the plug in position.

10. Then lock the roller brakes on the shredder.



11. Inspect the safety devices. Use the checklist in section 1 for the inspection.



## 4 Commissioning

### 4.1 Baling press controls

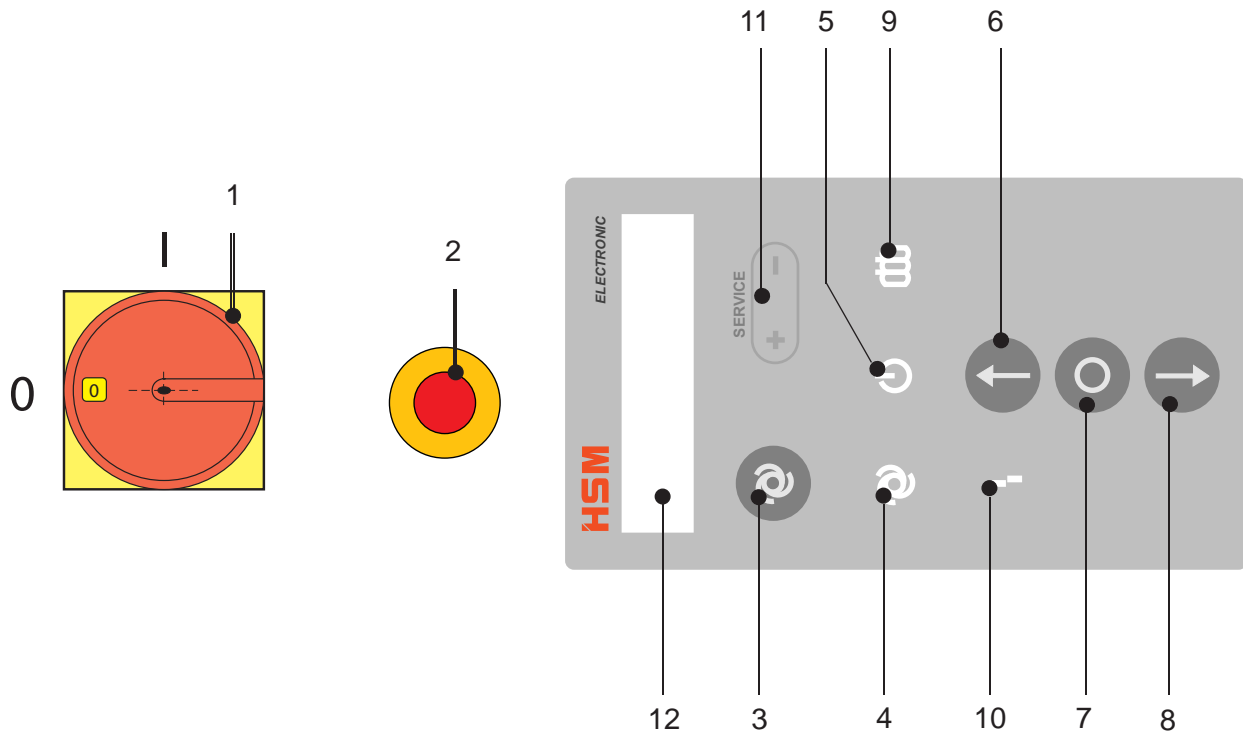

- 1 Main switch
- 2 Emergency stop
- 3 Automatic mode
- 4 Automatic mode (LED)
- 5 Standby (ready indicator)
- 6 Press ram forward
- 7 Press ram stop
- 8 Press ram backward
- 9 Bale ready
- 10 Malfunction
- 11.1 Menu selection / scroll up (+) / down (-)
- 11.2 Open press channel (+)
- 12 Text display

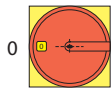
**Main switch (1)**

The main switch is on when it is turned 90° to the right.  
In the "Off" position, the main switch can be secured with a padlock.

**Emergency stop (2)**

Turn the "Emergency stop" button to the left unlock it.  
If you press the "Emergency stop" button the power circuit is broken. This switches off the baling press and the shredder.

**"Automatic mode" key (3)**

This key switches the baling press into automatic mode. Deselect the automatic mode by pressing the key again.

**"Automatic mode" LED (4)**

This symbol lights up yellow as soon as the automatic mode is switched on.

**"Standby" LED (5)**

This symbol lights up green as soon as the main switch is switched on and the machine receives power.  
This symbol flashes in the set-up mode or with the "Bale ready" message

**"Press ram forward" key (6)**

(arrow in direction of pressing)

This key starts the press cycle. The press ram moves forward and presses the material. After the compression time has expired, the press ram automatically moves to the rear limit position. The motor switches off.

**"Stop press ram" key (7)**

This key is used to stop the press ram in any position.

**"Press ram backward" key (8)**

(arrow opposite direction of pressing)

This key moves the press ram back to the rear limit position.



### “Bale ready” LED (9)

This symbol lights up blue as soon as the bale has reached a set size. The press ram stops, and the press and shredder switch off.

**Indicator: Bale ready**

**2-hand control**

The “Press ram status” symbol lights up yellow on the shredder control panel. The cutting unit of the shredder can now only be run backwards.

The “Bale ready” message remains active until the counter plate is closed. Then the

**Indicator: Manual mode**

**Bale number: xxx** (= daily bale meter reading) appears.



### “Malfunction” LED (10)

This symbol lights up red as soon as a malfunction occurs in the baling press. The press and shredder switch off.

(-> see also “**Malfunctions**”)

The machine cannot be started whilst this message is active!



### + / – Keys (11.1)

Press the +/- keys to scroll through the menu items.

See also the following pages.

### + Key (11.2)

Pressing this button + will open the bale channel and pressure-relieving

### Text display (12)

The text display shows the operating conditions and error messages.

(-> see also “**Malfunctions**”)

### 4.1.1 Accessing the SERVICE menu



#### Service menu / +/- Keys (11)

The service menu can only be called up in manual mode.

Simultaneously press the +/- keys for approx. 3 seconds to access the **Service** menu item

Use the +/- keys to scroll through the sub-menu items

**Setup mode - Daily bale counter - Balen length - Actual values - User language - Error memory - System**

Simultaneously press the +/- keys again for approx. 3 seconds whilst in the relevant sub-menu item, to gain further access within these menus.

Press the +/- keys to scroll through the menus.

Simultaneously press the +/- keys to confirm the values set.

Press any key to return to the main menu.

<b>Setup mode</b>				
Bale finished		Press ram		
Set	Reset	Press ram forw +		
		Press ram backw -		

<b>Daily bale counter</b>				
No. of bales: xx	No. of bales: xx			
Erase ? Yes	Erase ? No			

<b>Bale length</b>				
Nominal value: xxx				

<b>Actual values</b>				
Oil temperature	Total bale counter	Daily bale counter	Operating hours	
xx °C	xx	xx	xx	

<b>User language</b>				
D, GB, ...				

<b>Error memory</b>				
xxxx				

<b>System</b>				
Menu times				
Motor run-out time	Oil cooler off	Oil cooler on	Overloading	Starting time
xx s	xxx °C	xxx °C	xxx s	xxx s

## 4.1.1.1 Select setup mode (Bale finished / press channel / press ram)

- Simultaneously press the +/- keys for approx 3 seconds  
**Indicator: Service menu  
Setup mode**
  - Simultaneously press the +/- keys for approx 3 seconds  
**Indicator: Setup mode  
Bale finished**
  - Simultaneously press the +/- keys for approx 3 seconds  
**Indicator: Bale finished  
setting**
  - Scroll to the desired menu items using the +/- keys  
**set / reset**
  - Simultaneously press the +/- keys for acknowledgement
- 
- Simultaneously press the +/- keys for approx 3 seconds  
**Indicator: Service menu  
Setup mode**
  - Simultaneously press the +/- keys for approx 3 seconds  
**Indicator: Setup mode  
Bale finished**
  - Press the + key 1x  
**Indicator: Setup mode  
Press ram**
  - Simultaneously press the +/- keys for approx 3 seconds  
**Displayanzeige: Press ram forward +  
Press ram backward -**
  - Pressing the + key you can move the press ram forwards in inching operation
  - Pressing the – key you can move the press ram backwards in inching operation

## 4.1.1.2 To display / clear the daily bale meter

- Press the +/- keys simultaneously for about 3 seconds  
**Indicator: Service menu  
Setup mode**
- Press the + key 1x  
**Indicator: Service menu  
Bale/day**
- Press the +/- keys simultaneously for about 3 seconds  
**Indicator: Bale count xxx  
clear? yes/no**
- Use the +/- keys to scroll to the required menu item  
**clear yes / clear no**
- Press the +/- keys simultaneously to confirm

## 4.1.1.3 Displaying / adjusting: Bale length or No. of strokes

**Note**

*Bale length -> for baler with counting wheel  
No. of strokes -> for baler without counting wheel  
The options are set via DIP switches.*

- Press the +/- keys simultaneously for about 3 seconds  
**Indicator: Service menu  
Setup mode**
  - Press the + key 2x  
**Indicator: Service menu  
Bale length or No. of strokes**
  - Press the +/- keys simultaneously for about 3 seconds  
**Indicator: Bale length Nominal value xxx**
  - Scroll to the desired bale length using the +/- keys (200 mm ÷ 950 mm)
  - Scroll to the desired no. of strokes using the +/- keys (3 ÷ 20 compression strokes)
- (values adjusted by HSM: bale length 500 mm / no. of strokes is depending on material)*
- Simultaneously press the +/- keys for acknowledgement



## 4.1.1.4 Displaying / adjusting the actual values

- Simultaneously press the +/- keys for approx 3 seconds  
**Indicator: Service menu**  
**Setup mode**
- Press the + key **3x**  
**Indicator: Service menu**  
**Actual values**
- Simultaneously press the +/- keys for approx 3 seconds  
**Indicator: Oil temperature**  
**xxx°**
- Scroll to the desired menu items using the +/- keys  
**Total bale counter / Daily bale counter / Operating hours**  
  
**Indicator: Total bale counter**  
**xxx**  
 or  
**Indicator: Daily bale counter**  
**xxx**  
 or  
**Indicator: Operating hours**  
**xxx**

## 4.1.1.5 Adjusting the user language

The screen display can be adjusted for different user languages.

The following ones are available:

D - GB - F - E - I - P - NL - N - S - FIN - DK - GR - TR - PL - CZ - RUS

- Simultaneously press the +/- keys for approx 3 seconds  
**Indicator: Service menu**  
**Setup mode**
- Press the + key + Taste **4x**  
**Indicator: Service menu**  
**User language**
- Simultaneously press the +/- keys for approx 3 seconds  
**Indicator: User language**  
**D**
- Scroll to the desired language using the +/- keys
- Simultaneously press the +/- keys for acknowledgement  
**Indicator: Manual operation**  
**Nominal xxx Actual xxx**

#### 4.1.1.6 To display the error memory

For diagnostic purposes, the most recent error is stored in the error memory. For error numbers, see the section "**Malfunctions**"

- Press the +/- keys simultaneously for about 3 seconds  
**Indicator:   Service menu**  
**Setup mode**
  
- Press the + key 5x  
**Indicator:   Sevice menu**  
**Error memory**
  
- Press the +/- keys simultaneously for about 3 seconds  
**Indicator:   Error memory**  
**xxxx**

#### 4.1.1.7 System

This menu item is only available to HSM service technicians.

## 4.2 Shredder control panel

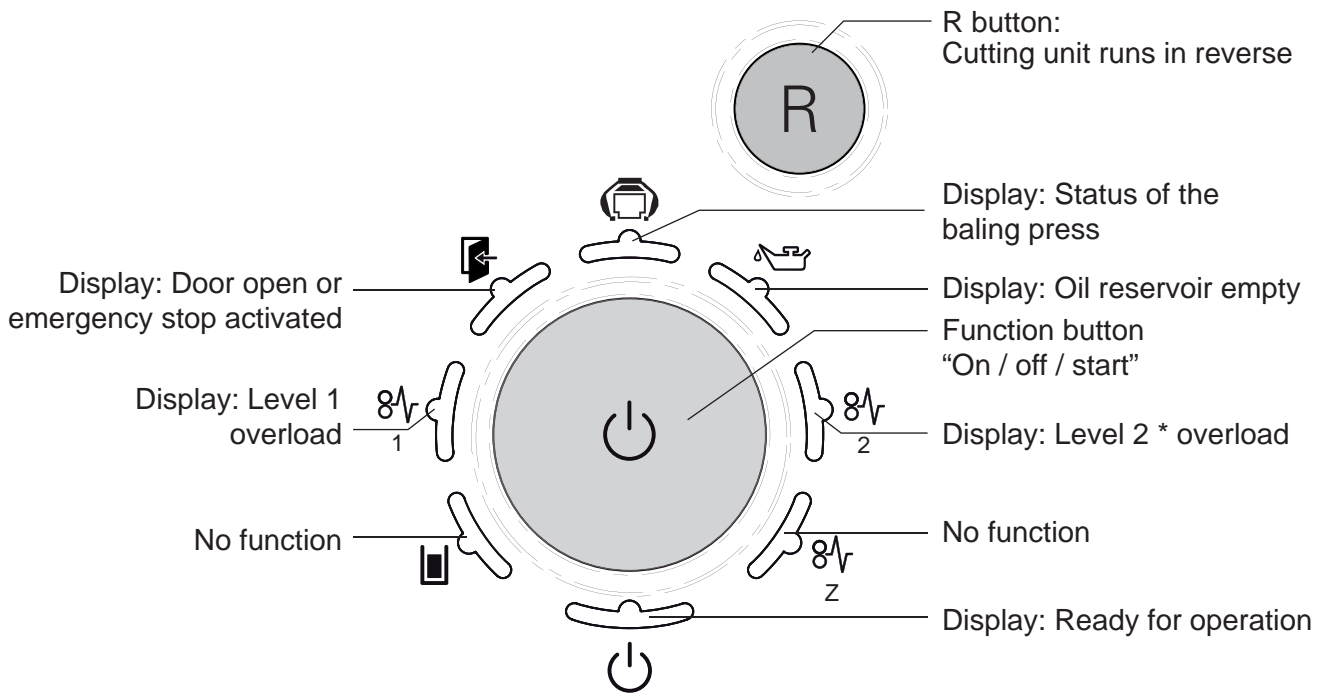

**Note**

*The shredder can only be operated, whilst the press is in automatic mode.*

### 4.2.1 Display: Baling press not in automatic mode

This symbol lights up red, if the press is not in automatic mode.

### 4.2.2 Display: Status of the baling press

This symbol lights up

green, whilst the press is in automatic mode.  
 yellow, when the bale is ready for strapping.  
 red, if a malfunction occurs in the baling press.

### 4.3 Initial start-up

- Open the inspection door on the hopper and check that the press chamber is clear, and remove any spare parts or supplies delivered with the machine
- Insert the CEE Plug into the socket on site.
- Activate the emergency stop control by pushing the switch bar away from the machine.
- Unlock the emergency stop on the press.
- Switch on the main switch of the press and the shredder.

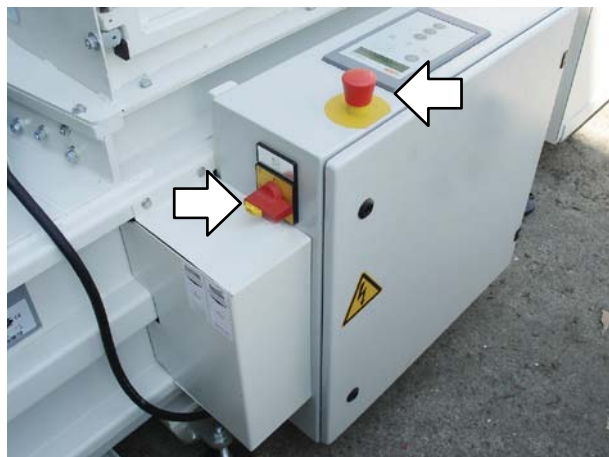
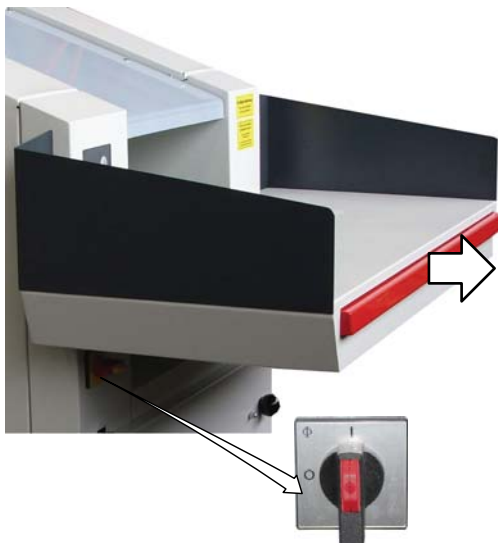

- After a self-test by the control, the **Indicator: Manual mode**  
**Norminal xxx Actual xxx**
- If the error number 1000 (= phase is absent) or 1010 (= counter-clockwise phase rotation) appear in the display -> call an electrician!  
See also the “Malfunctions” section



**Warning!**

*Faults in electrical components and supply cables may only be attended to by qualified electricians or HSM service engineers.*

- Close the control cabinet, before continuing to commission the machine.
- Set the desired user language
- Set the desired barrel length or number of strokes of the press cylinder  
Factory set value: body length 500 mm / stroke rate depends on the material

## 4.4 Running in the baling press

- Place the wooden frame (460 mm x 460 mm square timber: 120 mm x 120 mm) into the press channel



- Press the "Press ram forwards" key (arrow in compression direction)
  - the press ram moves forwards , automatically reverses and stops in its start position



- pressing the stop-key stops the movement of the press ram at any position; the movement can be continued by pressing the "Press ram forwards" or "Press ram backwards" keys

- Move press ram approx. 2 times forwards and backwards in manual operation

- This braces the wooden frame in the press channel (this step is required only when the press channel had been disassembled or the wooden frame had not yet been braced)



- Press the "Automatic operation" key on the baling press
- white light symbol "Automatic operation" comes up

**Indicator:    Automatic operation**  
**Nominal xxx Actual xxx**



- Display "Ready" light green at the shredder.



- Display "mode of the baler," the shredder is green.



- Press the start button
- The cutting unit and feed belt start up



- Place the material to be shredded on the loading table and then place batches on the infeed conveyor

If material that is not supposed to be shredded is mistakenly placed onto the conveyor belt do not try to pull it out, but

- Press the start button again
- The cutting unit and feed belt stop



- Press the R-button
- The cutting block and feed belt run in reverse
- When you release the R button, the shredder will be stop
- You can now remove the material from the belt and start the shredder again by pressing the start button



#### Note

*Provided the cutting unit is running in the shredding direction, you can stop it by pressing the R button.*

The shredded material falls through the discharge chute of the shredder directly into the hopper of the press.

The press cycle is initiated by the light barrier inside the hopper when a certain filling level is reached. The press ram moves forwards and compresses the material. The press ram automatically returns to its rear end position after expiry of the pressing time. The shredder continues running during the press cycle.

- Feed the paper shredder with material until the wooden frame is ejected at the end of the press channel during the compression process
- Switch off the main switch on the baling press
- Draw in the 3 strapping tapes (as described in section 4.5)

**Note**

*The first bales compressed during the running-in of the baling press are not yet perfectly compressed and shaped. Even compressing the ejected compression material again does not result in an optimum bale.*

- Switch on the main switch on the baling press
- Reload the unstrapped "running-in material" from the beginning through the inspection flap into the baling press
- Close the inspection flap



- Press the "Press ram forwards" key and compress all "running-in material" in this manner



- Press the "Automatic operation" key
- Following you can continue working automatically with the equipment

#### 4.4.1 Setting the press channel adjustment cylinder

The material is compressed and pushed into the conical press channel. The press channel opens and closes depending on the pressure.

The opening speed of the press channel can or must be adjusted depending on the type of material to be pressed (frictional resistance).

**Note**

*The press channel should open smoothly – not with a sudden jerk!*

**Close** the throttle screw to open the press channel more **slowly**

**Open** the throttle screw to open the press channel more **quickly**

Basic setting:

Close the throttle screw completely and open it by **1/8 of a turn**.



#### 4.4.2 Relieve the press channel

The press channel is to be relieved:

- a) before starting maintenance works
  - b) if the press channel has to be emptied or disassembled
  - c) if the pressing force of the press cylinder is not sufficient to shear off the material or to press the material into the tape repress channel. (shearing malfunction)
- Press the "Open channel" push button
  - the press channel is relieved, that means the adjustment cylinder lowers.



**Note**

*This is valid either for manual and automatic operation.  
It's also possible to relieve the press channel during operation.*



## 4.5 Drawing in the strapping tape

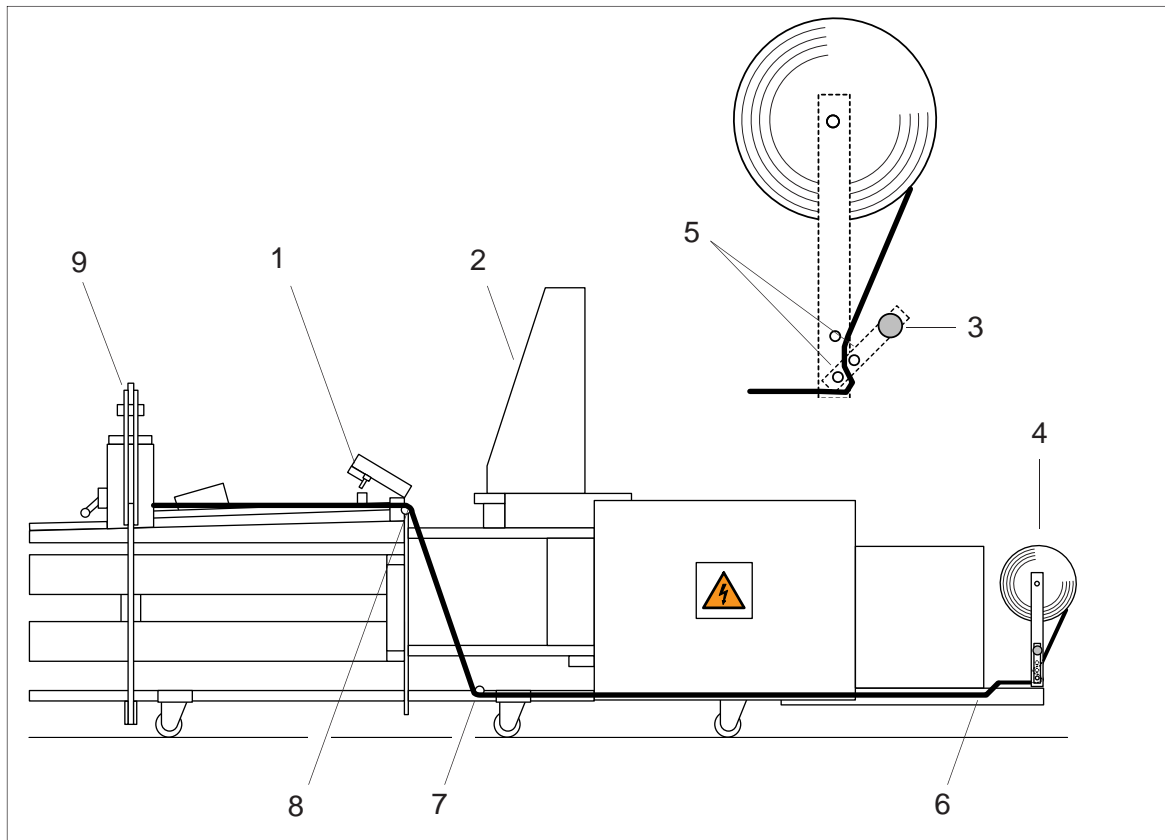

- Open the strapping flap (1) and the inspection door (2) on the hopper
- Pull the strapping tape (4) from the roll
- Open the tape brake (3) and pull the strapping tape through the bore hole (5)
- Push the strapping tape into the tube (6) until the tape comes out at the front of the press chamber (7)
- Pull the strapping tape upwards and through the eyelet (8)
- Pull the strapping tape forwards up to the press channel adjustment (9) and let it be placed upon the cover, so that the tape can run on when the new bale is compressed



**Caution!**

*Do not tie the tape end to the press channel because this can tear the tape off!*

- Close the strapping flap
- Take up the loose tape on the tape roll and close the tape brake

## 4.6 Automatic compression with light barrier



- Press the "Automatic operation" key
  - yellow light symbol "Automatic operation" comes up
- Indicator:    Automatic operation**  
**Nominal xxx Actual xxx**

- Now you can start feeding the paper shredder continuously

In this setting, the press ram automatically moves forwards and backwards until the beam of the light barrier is interrupted by compression material.

After the set bale length has been reached, the message "Bale finished - Strapping" is displayed and the press ram stops in its foremost position.

## 4.7 Strapping procedure

The press ram moves into its front position and stops in "Strapping" position under pressure. The bale must now be strapped three times. Proceed as follows:

- Open the strapping flap (1) and loosen the tape brake

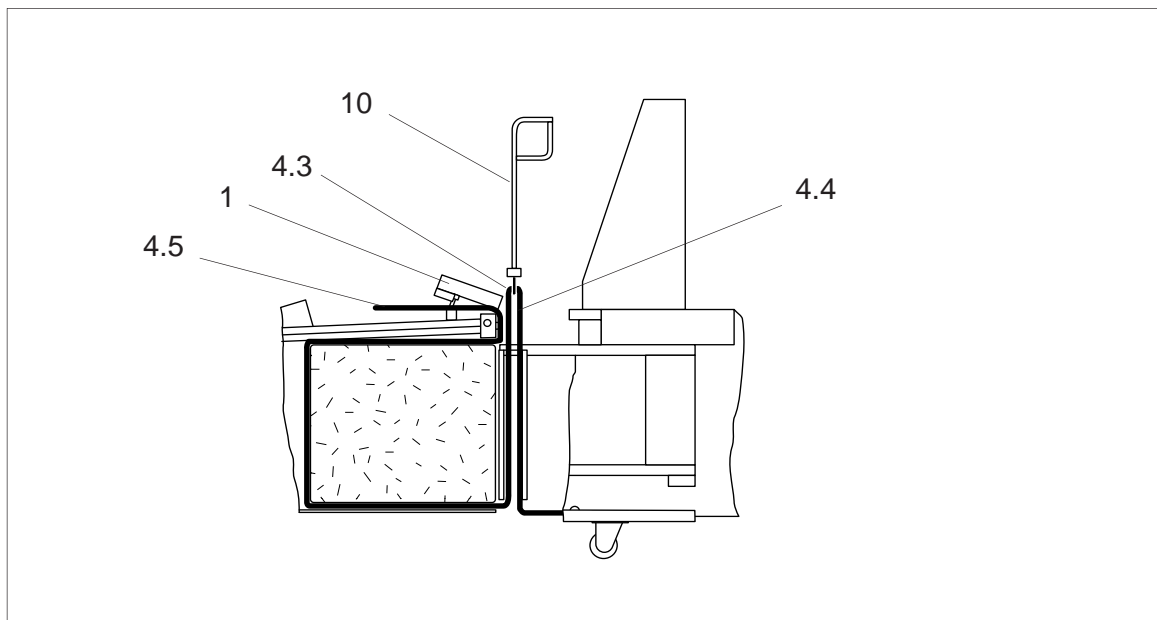

- Check whether the channels in the press ram are free from material and clean the channels using the tape insertion needle (10), if necessary

- Push down the tape insertion needle (10) through the first strapping channel of the press ram
- When the tape insertion needle is rotated by 90°, the catching claw grips the loose tape
- Pull the hooked-in strapping tape up and put the tape insertion needle to the side
- Cut the tape loop with a knife or a pair of scissors and knot the tape ends (4.5) and (4.3)

**Note**

*Make sure that you do not mix up the tape ends (4.3) and (4.4)!  
Bale strapping is then impossible!*

- Pull the cut tape (4.4) immediately through the respective lugs up to the press channel adjustment.

**Caution!**

*Do not tie the tape end to the press channel because this can tear the tape off!*

- Repeat this process for the 2nd and 3rd strapping process
- Close the strapping flap (1) and the tape brake

**Warning!**

*If the channels in the press ram are not cleared carefully, it could cause that a tape will be caught in the press ram and pulled in by the reverse movement of the press ram.*

*Never hold tight a tape with your hands, that is pulled in!  
Squeezing and cutting injuries could be the result.*

- The compression can now be initiated again with the "Automatic operation" key or manually with the "Press ram forwards" key

## 4.8 "Sacking" procedure

- Lift the tension lever (11)
- Pull the plastic sack (12) over the outlet opening and push it further on over the metal sheet (13)
- Lower the tension lever (11)
- the ready bale is automatically pushed into the plastic sack.

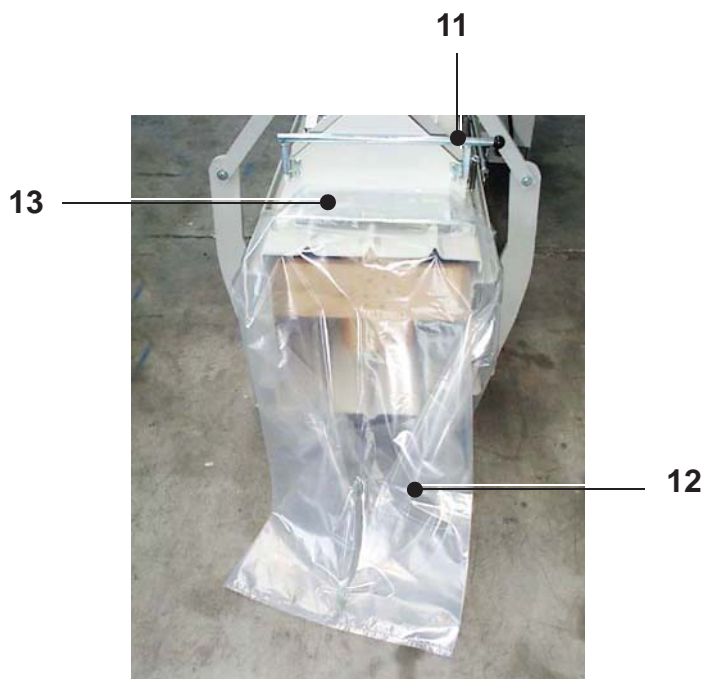

Accessories:  
Plastic sack

Order no.: 1 452 995 000

## 4.9 Malfunctions of the baling press

As soon as a malfunction occurs in the baling press, the red malfunction symbol  lights up. The baling press and shredder switch off and the relevant error message appears in the text display.



The “Baling press status” symbol  lights up red on the shredder.

The error number of the most recent error is stored in the error memory. Diverse, displayed error messages can be cleared by simultaneously pressing the + / – keys or by turning the machine on and off.

**Service - Hotline: +49 7544 2100-300**

### 4.9.1 Error numbers

Code	Description	Remedy
1000	One of the phases is missing / power input	Electrician! Check the fuses on site.
1010	A phase is wrong / counter-clockwise phase rotation	Electrician! Phase sequence on site / check phase rotation.
1100	Oil temperature too high	Let oil cool down
1110	Defective oil temperature sensor	Electrician! Replace sensor
1200	Motor protective switch has triggered off	Let Motor cool down - ~ 20 min. waiting
1201	Motor protective switch oil cooler has triggered off	Let Motor cool down - ~ 20 min. waiting
1210	Emergency stop on the press has been activated	Unlock the emergency stop button
1211	Emergency stop on the shredder has been activated	Unlock the emergency stop button
1222	Service door in the filling area of the press is open	Close the inspection flap
1223	Strapping flap is open	Close strapping flap
1271	“Extend press ram” timing	Check the movement of the press ram
1272	“Retract press ram” timing	Check the movement of the press ram
1273	Shearing malfunction	Remove material jam
1274	Compression malfunction	Check channel adjustment
1282	Inductive switch channel adjustment	Electrician! Check inductive switch
1290	Light barrier compression/material bridge	Remove material bridge / clean light barr.
1291	Light barrier overcharging/material bridge (option)	Remove material bridge / clean light barr.
1300	Defective hardware	Electrician! Consult HSM customer service
1310	Short-circuit master output stage	Electrician! Consult HSM customer service
1320	Short-circuit slave output stage	Electrician! Consult HSM customer service

## 4.10 Malfunctions of the shredder

### 4.10.1 Overload due to paper jam



- “Overload” display (level 1 or level 2 – depending on the machine model) lights up red.
- The drive automatically runs in reverse for several seconds. Then the cutting unit switches off..



**Caution!**

*The blade rollers can still cause injuries even while they are not running. Do not reach into the cutting unit!*

*Protective gloves should be worn at all times.*

*Do not repetitively run the cutting unit backwards and forwards, for the purpose of removing an obstruction. This will damage the shredder.*



- Remove the stack of paper.
- Press the automatic button on the press
- Press the start button and put less paper on the feed belt.



### 4.10.2 Electric motor overheats



- “Overload” display (level 1 or level 2 – depending on the machine model) flashes red.
- The drive automatically switches off.



- Let the motor cool down for 20–30 minutes.
- Press the automatic button on the press
- Press the start button.



### 4.10.3 Emergency stop activated



- Display lights up red.
- The baling press and shredder switch off.



- Activate the emergency stop control by pulling the switch bar away from the machine.
- Press the automatic button on the press
- Press the start button.



#### 4.10.4 Oil reservoir empty



- “Oil reservoir empty” display lights up blue.
- Refill the the cutting block special oil.  
Order no. 1.235.997.500 for a 5 l container
- After the reservoir is filled, the “Oil reservoir empty” signal is automatically deactivated.



#### Note

*The shredder remains operational even when the oil reservoir is empty.*

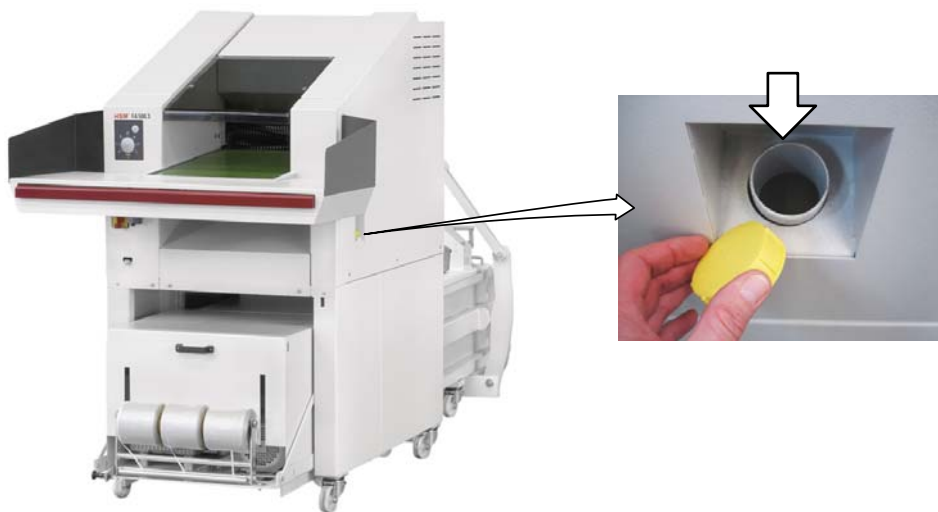

#### 4.11 Stopping the machine

- Run the machine into the initial position (with the press ram at the rear)
- Switch off the main switch of the shredder and of the press
- Secure the main switches against restarting
- Unplug the red CEE power plug

#### 4.12 Outdoor use



#### Warning!

*For reasons of safety, only operate under supervision. The operator must ensure that unauthorized persons do not have access to the machine.*

*When the machine is not being used, it must be shut down and secured against unauthorised use.*

See also the “Siting the machine” section

## 5 Inspection and maintenance work

### 5.1 Notes on maintenance



*Note*

*Malfunctions which are due to inadequate or incorrect maintenance can lead to expensive repairs and lengthy machine down-times. Regular maintenance is therefore essential. For this reason we recommend a maintenance and inspection contract.*



**Warning!**

*Correct any damage immediately. Escaping oil can cause fire and injury!*

*Maintenance and repair work on the electrical system or control cabinet may only be carried out by a qualified electrician or one of our service engineers*

All the inspection and maintenance tasks listed here apply to **single-shift operation**. The intervals must be reduced accordingly for multiple shift operation. The baling press must undergo a complete overhaul at least every two years.

Always refer to the “Safety” section during maintenance and inspection work.

Before performing such tasks make sure the drives and additional mechanisms of the baling press cannot be switched on unintentionally. Turn the main switch to the “0” position and secure it. Unplug the red CEE power plug.

Maintenance work may only be carried out by our specialist engineers or specially trained staff.

Only persons with the appropriate skills and experience in hydraulics may carry out work on the hydraulic equipment.

Empty the press channel before performing repair or maintenance work on the baling press



## 5.2 Maintenance of the baling press

### 5.2.1 Changing the hydraulic fluid / venting filter

Change the hydraulic fluid and the venting filter **every 2 years**

- Run the press ram to its rear limit position
- Turn off the main switch and disconnect the red CEE power plug
- Screw off the 2 screws on both sides of the cover (1)
- Take out the spindle (2) with the tape rolls and put it on the ground
- Remove the cover (H)



Venting filter  
Part. no. 6.116.195.090



- Remove the tank cover and extract the oil with an oil suction unit
  - The capacity of the hydraulic fluid tank is ~ 27 l
- If the tank is very dirty, clean it
- Mount the tank cover onto the unit again
- Add oil until a level between the notches on the oil level dipstick is reached

Oil grade:

- in accordance with DIN 51524-T3 multi-grade oil / ISO viscosity grade HVLP 22

	ISO- Viskositäts- klasse	ESSO	DEA	SHELL	ARAL	BP	FINA
Mineralöle Mineral oils	<b>ISO VG 22 HVLP</b>	UNIVIS N 22	Astron ZHLP 22	Tellus Öl T 22	Aral Vitam HF 22	Bartran HV 22	HYDRAN HV 22

- Run the press ram forwards and backwards several times and, whilst the press ram is as far forward as possible, recheck the oil level
- Fill more oil if required
- Screw on a new venting filter
- Mount the cover (H) onto the unit again
- Put the spindle (2) with the tape rolls back again



**Note**

*Observe the applicable accident prevention regulations when handling cleaning agents and solvents*

*Observe the environment protection regulations when disposing of waste oil.*

*Never mix hydraulic fluid and cleaning agent mixtures with waste oil. Collect these substances in separate containers and dispose of them according to the regulations.*

## 5.2.2 Oiling and greasing moving parts

The press ram guide is almost maintenance-free. The rollers used have a grease filling which lasts their service life.

The sliding guide elements on the side are made of wear-resistant, glass fibre-reinforced plastics. All moving parts and hinges, especially the door hinges as well as the door lock itself must be lubricated as required.

### 5.2.3 Empty the dust tray

- Switch the main switch off
- Empty the dust tray beneath the baling press once a week
- Be careful to make sure when you slide the the dust tray under the press that the safety switch snaps in it's position
- Clean the area beneath the baling press -> remove all soil particles!



## 5.3 Maintenance of the FA 500.3 shredder

### 5.3.1 Lubricating the drive chains and synchronized wheels (2 x per year)

- Turn off the main switch and disconnect the red CEE power plug
- Remove the inspection flaps (1) in the left and right side plates. Take out the Allen screws (2).
- Lubricate the drive chain of the motor and cutting unit, the drive chain of the cutting unit and feed belt, and the synchronized wheels.  
Recommended lubricant: K2K in accordance with DIN 51502/DIN 51825

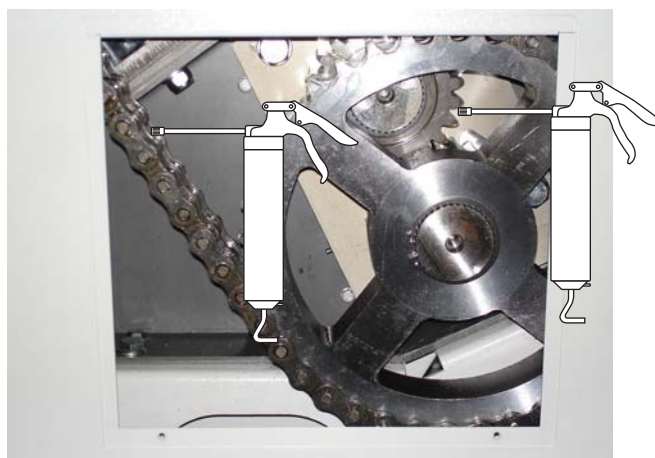

- Mount the inspection flaps onto the unit again.

### 5.3.2 Retighten the feed belt

- Turn off the shredder
- Loosen the hex nuts (3) on the left and right sides of the snub roller.  
(Accessible from the below)
- Loosen the lock nuts (4) of the tensioning bolts (5).
- Tighten the feed belt evenly using the tensioning bolts.

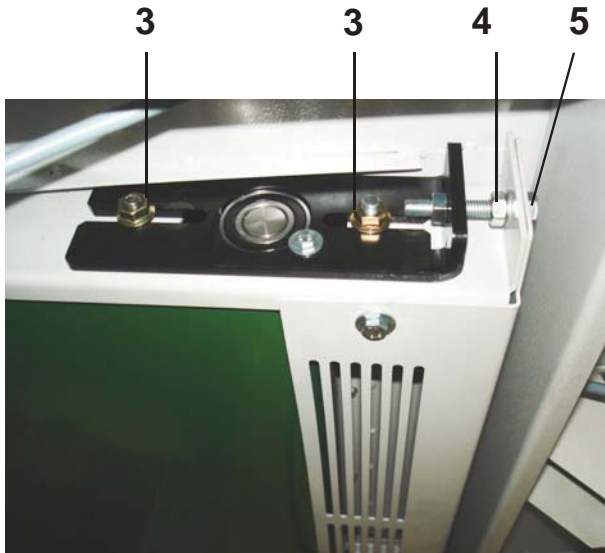

**Note**

*Only tighten the feed belt until it stops slipping. The feed belt bearing may be damaged if it is tightened too much.*

- Tighten the hex nuts on the snub roller and the lock nuts on the tensioning bolts again.

### 5.3.3 Check the directional stability of the feed belt

Switch on the shredder and let it run for approx. 10 minutes.

During this time, the feed belt must run in the middle of the snub roller. If it slips to the left or right edge, you must alter the setting of the snub roller.

### 5.3.4 Check the feed belt for wear

The surface of the feed belt can become worn after long periods of use. If you can see the fabric inlay in the belt, it must be replaced.

Please notify our customer service.

### **5.3.5 Emptying the collecting tray**

- Empty the dirt tray under the feed belt as required
- Clean the area under the Shredder – vacuum the particles of dirt



## **6 Storage**

If the shredder press combination is to be stored for a lengthy period, make sure that:

- the shredder press combination is disconnected from the power sources
- the shredder press combination is not directly exposed to the weather
- the hydraulic tank, pipes and hoses do not leak

## **7 Disposal instructions**

HSM baling presses / shredders have a long service life. Nevertheless, every machine reaches a time when inspections and repairs are no longer worth the trouble. The operator then faces the problem of disposing of the machine properly

We will be glad to advise you about the legal regulations for disposal at the appropriate time.

The baling press and shredder are made of different materials and need to be disassembled to separate the materials for recycling. (Ferrous materials, electrical components, plastics)

The hydraulic tank, pipes and hoses must be drained. It is important to ensure that leaking or spilled liquids are disposed of using appropriate binding agents or technical facilities, and do not enter the water, the ground or the sewer system. In disposing of the respective hydraulic fluids, the national legal requirements must be observed.





## 8 Using and ordering spare parts

**Only use original HSM spare parts!**

When ordering spare parts, please always provide:

- **the complete machine number**
- **the year of construction of the baling press**

<b>HSM</b> ®		HSM GmbH+Co.KG Austraße 1-9 D-88699 Frickingen Germany	
MODELL		CE	
MASCH.-NR.:	<input type="text"/>		
SERIEN - NR.:	<input type="text"/>		
PRESSKRAFT:		kN	
SPANNUNG:	V	Hz	LEISTUNG: kW
BAUJAHR:		NENNSTROM:	A

### 8.1 Customer service address

**HSM GmbH + Co.KG**  
 Austraße 1-9  
 88699 Frickingen, Germany  
 Tel. +49 7554-2100-300  
 Fax +49 7554-2100-197  
 support@hsm.eu

## **9 Electrical circuit diagrams**

The wiring diagrams are supplied separately with the machine.  
(in the control cabinet)



## 11 EC declaration of conformity

# EC declaration of conformity

The manufacturer **HSM GmbH + Co. KG**  
**Austraße 1-9**  
**D - 88699 Frickingen**

hereby declares that the described **SP 5088 shredder press combination**, consisting of the FA 500.3 shredder and the KP 88.1 baling press, comply with the basic safety and health requirements of the following EC directives:

- 2006/42/EG
- 2004/108/EG

*Applied standards and technical specifications:*

EN1010-3:2002+A1, EN ISO 12100-1:2003+A1:2009, EN ISO 12100-2:2003+A1:2009,  
EN ISO 13857:2008, EN 13849-1 (2008), EN 60204-1:2006+A1:2009,  
EN 349:1993+A1:2008, EN 55014-1:2006+A1:2009, EN 61000-6-4 (01.07), EN 61000-6-2 (03.06)

The individual operation of the machines is prohibited. Only the combination of the shredder and the baling press complies with EN 13857 (safety distances).

Salem, 15.02.2011



p. p. Hubert Kötzinger  
Head of Environmental Engineering Product Development

Authorised representative for the compilation of technical documentation:  
Hubert Kötzinger, HSM GmbH + Co. KG.

The technical documentation in terms of Appendix VII, Part A has been created and is available at HSM GmbH + Co.KG.

This declaration only relates to those machines that are in the same condition as they were when put into circulation, no regard can be to parts added later by the end user and/or any work conducted subsequently.